

General Description

These N-Channel enhancement mode power field effect transistors are using SGT technology. This advanced technology has been especially tailored to minimize on-state resistance, provide superior switching performance, and withstand high energy pulse in the avalanche and commutation mode. These devices are well suited for high efficiency fast switching applications.

Features

V_{DS}	45V
I_D (at $V_{GS}=10V$)	36A
$R_{DS(ON)}$ (at $V_{GS}=10V$)	6.5m Ω (Typ)

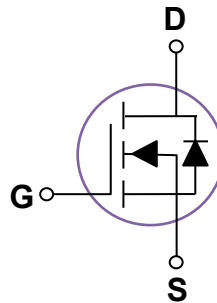

Absolute Maximum Ratings $T_A=25^{\circ}C$ unless otherwise noted

Parameter	Symbol	Maximum	Units
Drain-Source Voltage	V_{DS}	45	V
Gate-Source Voltage	V_{GS}	± 20	V
Drain Current-Continuous	TC=25 $^{\circ}C$	I_D	36 A
	TC=100 $^{\circ}C$	I_D	25 A
Maximum Power Dissipation	P_D	30	W
Single pulse avalanche energy	E_{AS}	20	mJ
Junction and Storage Temperature Range	T_J, T_{STG}	-55 To 150	$^{\circ}C$

Thermal Characteristics

Parameter	Symbol	Typ	Max	Unit
Thermal Resistance junction-case	$R_{\theta Jc}$		1.3	$^{\circ}C/W$
Thermal Resistance junction-to-Ambient	$R_{\theta JA}$		62	$^{\circ}C/W$

Electrical Characteristics (T_J=25°C unless otherwise noted)

Symbol	Parameter	Condition	Min	Typ	Max	Unit
STATIC PARAMETERS						
BV _{DSS}	Drain-Source Breakdown Voltage	V _{GS} =0V, I _D =250μA	45			V
I _{DSS}	Zero Gate Voltage Drain Current	V _{DS} =40V, V _{GS} =0V			1	μA
I _{GSS}	Gate-Body Leakage Current	V _{GS} =±20V, V _{DS} =0V			±100	nA
V _{GS(th)}	Gate Threshold Voltage	V _{DS} =V _{GS} , I _D =250μA	1.0	1.6	2.5	V
R _{DS(ON)}	Drain-Source On-State Resistance	V _{GS} =10V, I _D =15A		6.5	8.0	mΩ
		V _{GS} =4.5V, I _D =10A		10	13	mΩ
g _{fs}	Forward Transconductance	V _{DS} =10V, I _D =40A		6		S
DYNAMIC PARAMETERS						
C _{ISS}	Input Capacitance	V _{DS} =20V, V _{GS} =0V, F=1.0MHz		740		pF
C _{OSS}	Output Capacitance			285		pF
C _{RSS}	Reverse Transfer Capacitance			25		pF
SWITCHING PARAMETERS						
t _{d(on)}	Turn-on Delay Time	V _{DD} =20V, I _D =40A, V _{GS} =10V, R _G =3Ω		5		nS
t _r	Turn-on Rise Time			47		nS
t _{d(off)}	Turn-Off Delay Time			15		nS
t _f	Turn-Off Fall Time			6.5		nS
Q _g	Total Gate Charge	V _{DS} =20V, I _D =40A, V _{GS} =10V		14		nC
Q _{gs}	Gate-Source Charge			2.6		nC
Q _{gd}	Gate-Drain Charge			3.3		nC
V _{SD}	Diode Forward Voltage	V _{GS} =0V, I _{SD} =1A		0.72	1.3	V
R _g	Gate resistance	V _{GS} =0V, V _{DS} =0V, F=1MHz		1.7		Ω

Note:

1. Repetitive Rating : Pulsed width limited by maximum junction temperature.
2. V_{DD}=25V, V_{GS}=10V, L=0.5mH, I_{AS}=8A, Starting T_J=25°C
3. The data tested by pulsed , pulse width ≅ 300us , duty cycle ≅ 2%.
4. Essentially independent of operating temperature.

TYPICAL ELECTRICAL AND THERMAL CHARACTERISTICS

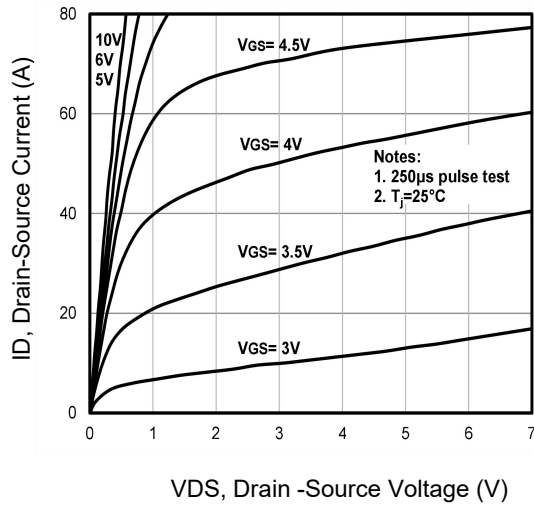

Fig.1. Typical Output Characteristics

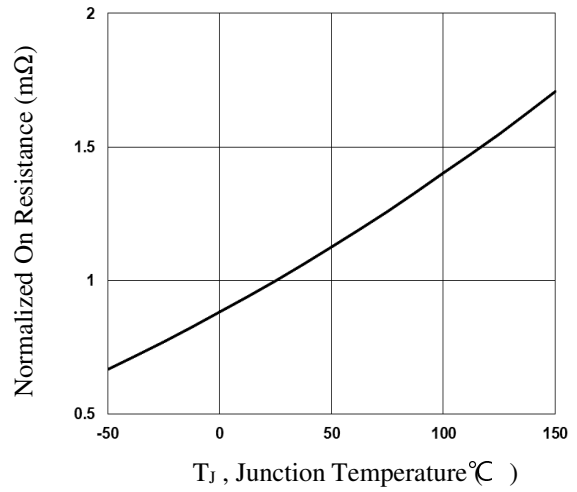

Fig.2 Normalized RDSON vs. T_J

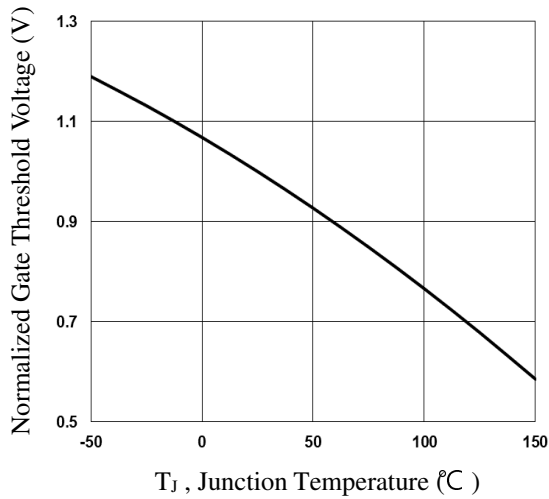

Fig.3 Normalized V_{th} vs. T_J

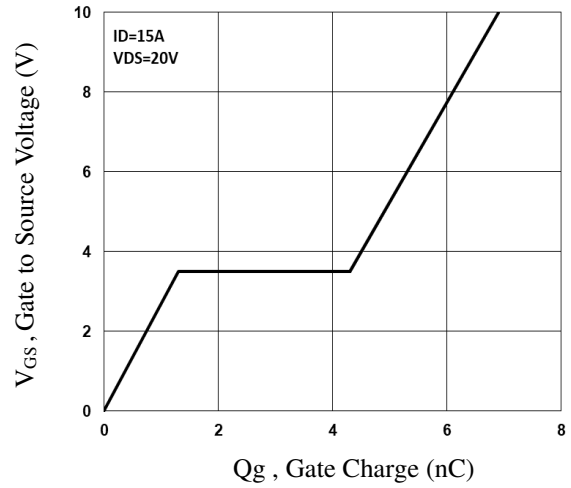

Fig.4 Gate Charge Waveform

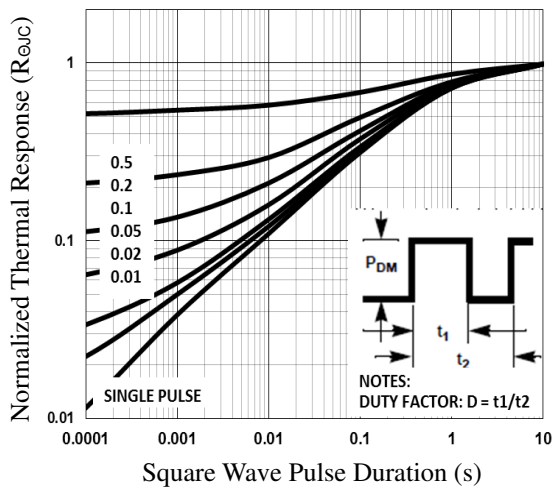

Fig.5 Normalized Transient Response

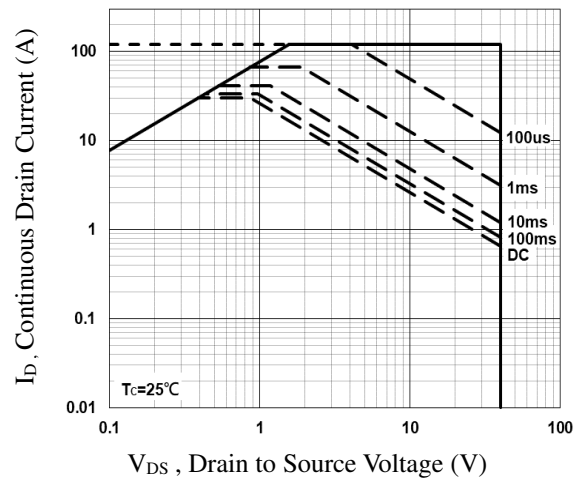

Fig.6 Maximum Safe Operation Area

TYPICAL ELECTRICAL AND THERMAL CHARACTERISTICS

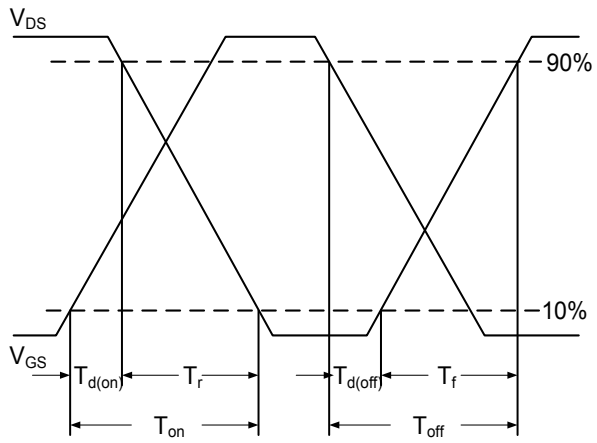

Fig.7 Switching Time Waveform

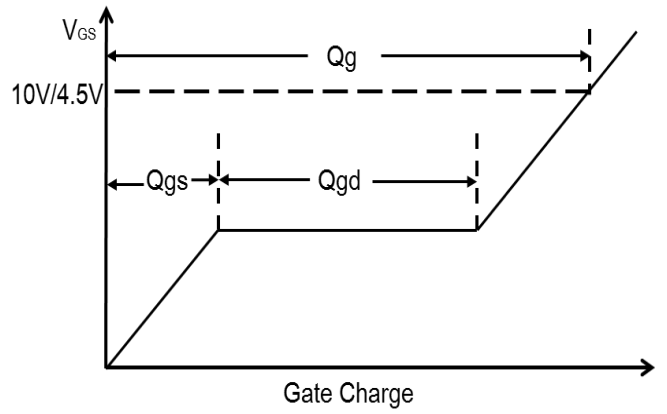
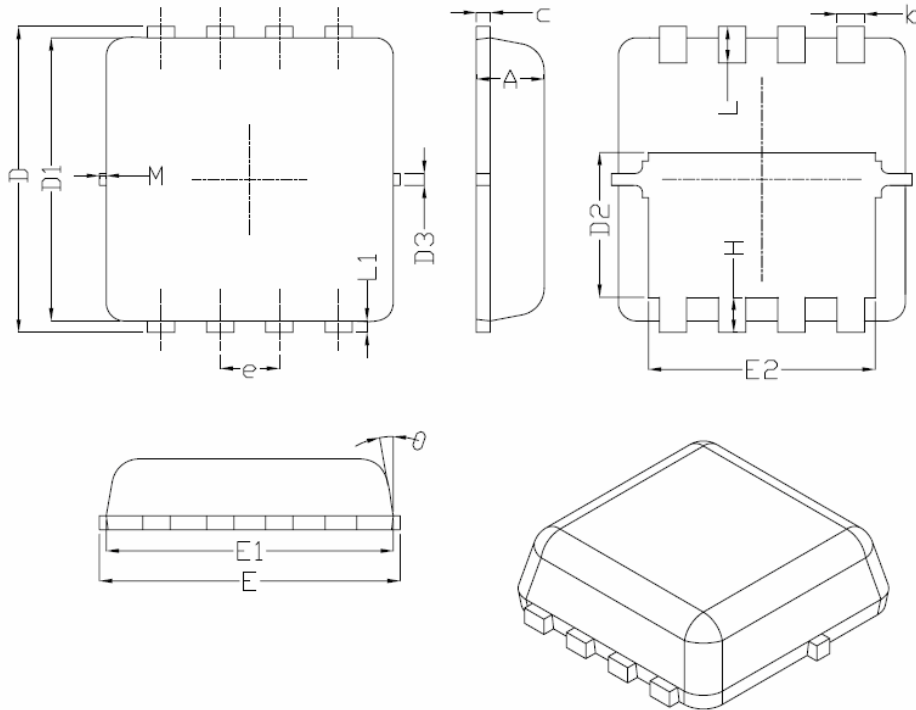

Fig.8 Gate Charge Waveform

PDFN3x3 PACKAGE INFORMATION



Symbol	Dimensions In Millimeters		
	Min.	Nom.	Max.
A	0.70	0.75	0.80
b	0.25	0.30	0.35
c	0.10	0.15	0.25
D	3.25	3.35	3.45
D1	3.00	3.10	3.20
D2	1.48	1.58	1.68
D3	-	0.13	-
E	3.20	3.30	3.40
E1	3.00	3.15	3.20
E2	2.39	2.49	2.59
e	0.65BS		
H	0.30	0.39	0.50
L	0.30	0.40	0.50
L1	-	0.13	-
M	*	*	0.15
θ		10°	12°